

INSULATED CHIMNEYS

TYPE KF NEGATIVE PRESSURE

Example of marking elements manufactured according to the standard EN 1856-1

	EN 1856-1	T450	N1	W	V _m	L50080	G100
Standard number	↓						
Maximum working temperature		↓					
Pressure class <i>N: negative pressure, P: positive pressure</i>			↓				
Resistance to condensate (<i>W: wet, D: dry</i>)				↓			
Resistance to corrosion according to type and thickness of material					↓		
Material specification (<i>50-1.4404, 20-1.4301, 30-1.4307</i>)						↓	
Thickness of material (<i>0.XX mm</i>)							↓
Resistance to soot fire (<i>G:yes; O:no</i>), distance from flammable materials (<i>100 mm</i>)							↓

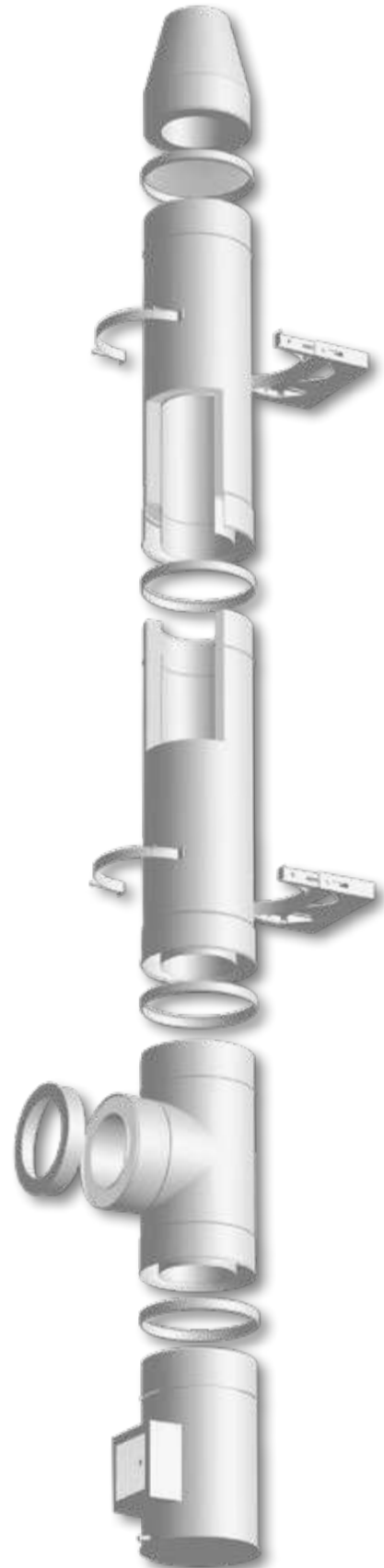

INSULATED CHIMNEYS

TYPE KF NEGATIVE PRESSURE

Insulated chimneys by Komin-Flex are used to carry off exhaust flue gases from gas, oil or solid fuel heating units. Properly assembled chimneys fully conform to domestic and European building and fire-safety standards. Insulated chimneys may be used in residential buildings as well as in widely understood industrial buildings.

After the segments are assembled, the insulated chimneys, depending on the options of execution, may be mounted with the use of special clasps to the walls of buildings, neighboring structures (e.g. boiler stations) or supported on independent support structures. The insulated chimneys are fully resistant to weather conditions, they ensure a safe temperature of external walls regardless of the temperature of exhaust flue gases, they are non-flammable and safe if soot catches fire, they are also resistant to condensate.

The elements of insulated chimneys consist of:

- an internal chimney liner made from acid-proof austenitic steel
- thermal insulation from special mineral wool, standard thickness at least 50 mm and density approx. 100 kg/m³
- an external jacket usually made from acid-proof steel type 1.4301 with reflective surface.

A properly selected and assembled chimney guarantees operation above dew point of exhaust flue gases which reduces the condensation of steam.

A characteristic feature of insulated chimneys type KOMIN-FLEX is their high rigidity due to a socket joint, length 100 mm as well as a high thermal resistance making it possible to install the chimneys under the heaviest weather conditions. Properly inverted sockets of the joints (the coupler) of the internal pipe and the jacket provide insulation against dampening both from the inside and from the outside. The special structure of the elements and applied insulation materials eliminate (on the entire chimney length) the presence of heat bridges as well as the necessity to use the compensators of linear expansion by ensuring free operation (extension and shortening resulting from the thermal expansion of steel) for the internal liner with respect to the external jacket. The specific structure and additional connections by means of mounting clamps guarantee high rigidity and tightness for the system and safety of use.

Negative pressure insulated chimneys KOMIN-FLEX comply with the following European standards: EN 1443, EN 1856-1 and the Polish standard PN-93/B-02870. The production of insulated chimneys is covered by the system of factory production control, certificate No 1020-CPD-070038635 (TZUS Praga). KOMIN-FLEX has implemented and maintains a quality management system compliant with the requirements of the standard EN ISO 9001:2015 certified by TZUS Praga.

Chimneys by KOMIN-FLEX have received a positive opinion and are recommended by the professional association of Polish chimney sweeps.

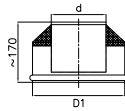

MOUTHPIECE *in diameters 150, 180 i 200 mm the tip of the mouthpiece makes it possible to mount chimney covers

trade diam.	110	120	130	140	150	160	180	200	225	250	300	350	400	450	500
d	110	120	130	140	150	160	180	200	225	250	300	350	400	450	500
D1	215	225	235	235	253	253	285	302	330	355	405	453	503	553	603

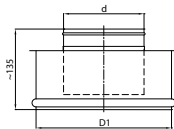

UPPER INSULATION ENDING

trade diam.	110	120	130	140	150	160	180	200	225	250	300	350	400	450	500
D1	215	225	235	235	253	253	285	302	330	355	405	453	503	553	603

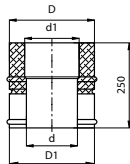

PIPE 0,25 m

trade diam.	110	120	130	140	150	160	180	200	225	250	300	350	400	450	500
d	111	122	132	139	152	161	180	201	226	251	300	351	401	451	501
d1	113	124	134	141	154	163	182	203	227	253	302	353	403	453	503
D	213	223	233	233	251	251	283	300	328	353	403	451	501	551	601
D1	215	225	235	235	253	253	285	302	330	355	405	453	503	553	603

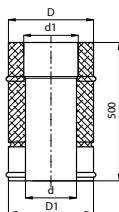

PIPE 0,5 m

trade diam.	110	120	130	140	150	160	180	200	225	250	300	350	400	450	500
d	111	122	132	139	152	161	180	201	226	251	300	351	401	451	501
d1	113	124	134	141	154	163	182	203	227	253	302	353	403	453	503
D	213	223	233	233	251	251	283	300	328	353	403	451	501	551	601
D1	215	225	235	235	253	253	285	302	330	355	405	453	503	553	603

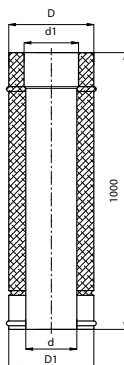

PIPE 1 m

trade diam.	110	120	130	140	150	160	180	200	225	250	300	350	400	450	500
d	111	122	132	139	152	161	180	201	226	251	300	351	401	451	501
d1	113	124	134	141	154	163	182	203	227	253	302	353	403	453	503
D	213	223	233	233	251	251	283	300	328	353	403	451	501	551	601
D1	215	225	235	235	253	253	285	302	330	355	405	453	503	553	603

ADJUSTABLE ELEMENT

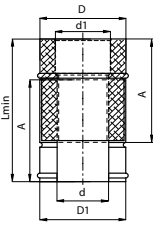

trade	110	120	130	140	150	160	180	200	225	250	300	350	400	450	500
diam.	210	220	230	230	250	250	280	300	325	350	400	450	500	550	600
d	111	122	132	139	152	161	180	201	226	251	300	351	401	451	501
d1	113	124	134	141	154	163	182	203	227	253	302	353	403	453	503
D	213	223	233	233	251	251	283	300	328	353	403	451	501	551	601
D1	215	225	235	235	253	253	285	302	330	355	405	453	503	553	603

Lmin	A	Lmax
400	300	500
600	500	900
900	800	1500

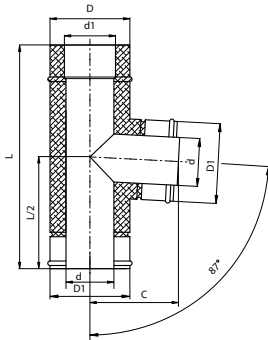

TEE 87°

trade	110	120	130	140	150	160	180	200	225	250	300	350	400	450	500
diam.	210	220	230	230	250	250	280	300	325	350	400	450	500	550	600
d	111	122	132	139	152	161	180	201	226	251	300	351	401	451	501
d1	113	124	134	141	154	163	182	203	227	253	302	353	403	453	503
D	213	223	233	233	251	251	283	300	328	353	403	451	501	551	601
D1	215	225	235	235	253	253	285	302	330	355	405	453	503	553	603
L	500	500	500	500	500	600	600	600	600	700	700	800	800	900	900
C	255	260	265	270	275	280	290	300	313	325	350	375	400	425	450

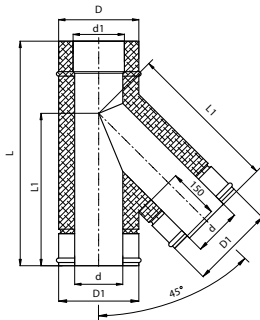

TEE 45°

trade	110	120	130	140	150	160	180	200	225	250	300	350	400	450	500
diam.	210	220	230	230	250	250	280	300	325	350	400	450	500	550	600
d	111	122	132	139	152	161	180	201	226	251	300	351	401	451	501
d1	113	124	134	141	154	163	182	203	227	253	302	353	403	453	503
D	213	223	233	233	251	251	283	300	328	353	403	451	501	551	601
D1	215	225	235	235	253	253	285	302	330	355	405	453	503	553	603
L1	406	416	428	440	452	464	488	512	542	573	633	696	756	817	877
L	600	600	600	700	700	700	700	800	800	800	900	1000	1000	1100	1200

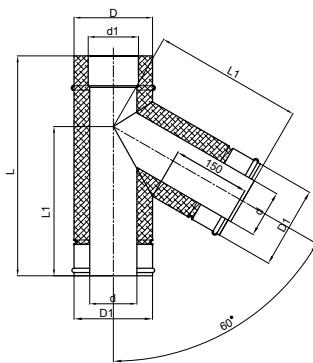

TEE 60°

trade	110	120	130	140	150	160	180	200	225	250	300	350	400	450	500
diam.	210	220	230	230	250	250	280	300	325	350	400	450	500	550	600
d	111	122	132	139	152	161	180	201	226	251	300	351	401	451	501
d1	113	124	134	141	154	163	182	203	227	253	302	353	403	453	503
D	213	223	233	233	251	251	283	300	328	353	403	451	501	551	601
D1	215	225	235	235	253	253	285	302	330	355	405	453	503	553	603
L1	334	343	351	359	367	377	394	410	433	455	499	547	585	633	671
L	600	600	600	600	600	600	600	700	700	800	800	900	900	1000	1000

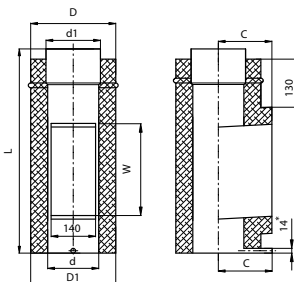

INSULATED CLEANING HOLE

trade	110	120	130	140	150	160	180	200	225	250	300	350	400	450	500
diam.	210	220	230	230	250	250	280	300	325	350	400	450	500	550	600
d	111	122	132	139	152	161	180	201	226	251	300	351	401	451	501
d1	113	124	134	141	154	163	182	203	227	253	302	353	403	453	503
D	213	223	233	233	251	251	283	300	328	353	403	451	501	551	601
D1	215	225	235	235	253	253	285	302	330	355	405	453	503	553	603
C	135	140	145	150	155	160	170	180	195	205	230	255	280	305	330
L	400	400	400	400	400	400	400	400	400	400	600	600	600	600	600
W	140	140	140	140	140	140	140	140	140	140	280	280	280	280	280

*above the diameter of 250mm dimension of the condensate collector tube is $\varnothing 25\text{mm}$
 **in diameters 150,160,180 and 200 option with 140x280 hole

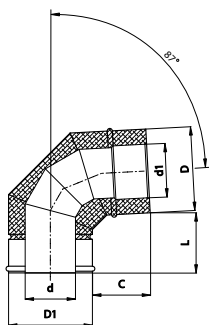

ELBOW 87°

trade diam.	110	120	130	140	150	160	180	200	225	250	300	350	400	450	500
	210	220	230	230	250	250	280	300	325	350	400	450	500	550	600
execution	4 segments					3 segments									
d	111	122	132	139	152	161	180	201	226	251	300	351	401	451	501
d1	113	124	134	141	154	163	182	203	227	253	302	353	403	453	503
D	213	223	233	233	251	251	283	300	328	353	403	451	501	551	601
D1	215	225	235	235	253	253	285	302	330	355	405	453	503	553	603
C	167	167	167	167	167	167	167	167	167	167	167	187	187	187	187
L	180	180	180	180	180	180	180	180	180	180	180	200	200	200	200

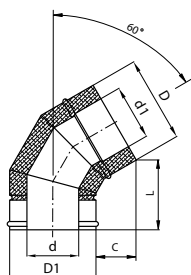

ELBOW 60°

trade diam.	110	120	130	140	150	160	180	200	225	250	300	350	400	450	500
	210	220	230	230	250	250	280	300	325	350	400	450	500	550	600
d	111	122	132	139	152	161	180	201	226	251	300	351	401	451	501
d1	113	124	134	141	154	163	182	203	227	253	302	353	403	453	503
D	213	223	233	233	251	251	283	300	328	353	403	451	501	551	601
D1	215	225	235	235	253	253	285	302	330	355	405	453	503	553	603
C	142	142	142	142	142	142	142	142	142	142	142	159	159	159	159
L	247	247	247	247	247	247	247	247	247	247	247	277	277	277	277

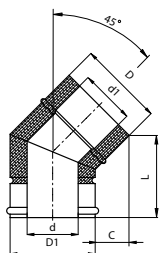

ELBOW 45°

trade diam.	110	120	130	140	150	160	180	200	225	250	300	350	400	450	500
	210	220	230	230	250	250	280	300	325	350	400	450	500	550	600
d	111	122	132	139	152	161	180	201	226	251	300	351	401	451	501
d1	113	124	134	141	154	163	182	203	227	253	302	353	403	453	503
D	213	223	233	233	251	251	283	300	328	353	403	451	501	551	601
D1	215	225	235	235	253	253	285	302	330	355	405	453	503	553	603
C	91	91	91	91	91	91	91	91	91	91	91	105	105	105	105
L	222	222	222	222	222	222	222	222	222	222	222	256	256	256	256

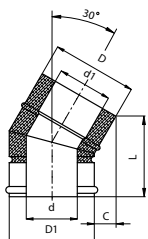

ELBOW 30°

trade diam.	110	120	130	140	150	160	180	200	225	250	300	350	400	450	500
	210	220	230	230	250	250	280	300	325	350	400	450	500	550	600
d	111	122	132	139	152	161	180	201	226	251	300	351	401	451	501
d1	113	124	134	141	154	163	182	203	227	253	302	353	403	453	503
D	213	223	233	233	251	251	283	300	328	353	403	451	501	551	601
D1	215	225	235	235	253	253	285	302	330	355	405	453	503	553	603
C	64	64	64	64	64	64	64	64	64	64	64	74	74	74	74
L	243	243	243	243	243	243	243	243	243	243	243	280	280	280	280

COUNTERBALANCE CONSOLE

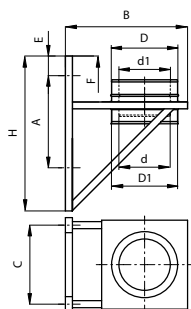

trade diam.	110	120	130	140	150	160	180	200	225	250	300	350	400	450	500
	210	220	230	230	250	250	280	300	325	350	400	450	500	550	600
d	111	122	132	139	152	161	180	201	226	251	300	351	401	451	501
d1	113	124	134	141	154	163	182	203	227	253	302	353	403	453	503
D	213	223	233	233	251	251	283	300	328	353	403	451	501	551	601
D1	215	225	235	235	253	253	285	302	330	355	405	453	503	553	603
B				400					500		600		700		750
C				285					380		500		600		650
H				420					500		750		850		900
A				180					270		450		550		600
E				50					50		50		50		50
F				100					100		100		100		100

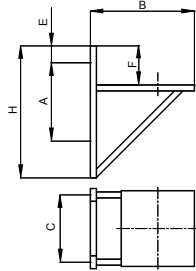

SUPPORT CONSOLE

trade diam.	110	120	130	140	150	160	180	200	225	250	300	350	400	450	500
	210	220	230	230	250	250	280	300	325	350	400	450	500	550	600
B			400					500			600		700		750
C			285					380			500		600		650
H			420					500			750		850		900
A			180					270			450		550		600
E			50					50			50		50		50
F			100					100			100		100		100
operating diameter			9					11			13		13		13

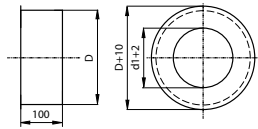

INSULATION ENDING

trade diam.	110	120	130	140	150	160	180	200	225	250	300	350	400	450	500
	210	220	230	230	250	250	280	300	325	350	400	450	500	550	600
d	111	122	132	139	152	161	180	201	226	251	300	351	401	451	501
d1	113	124	134	141	154	163	182	203	227	253	302	353	403	453	503
D	213	223	233	233	251	251	283	300	328	353	403	451	501	551	601
D1	215	225	235	235	253	253	285	302	330	355	405	453	503	553	603

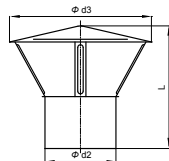

CHIMNEY CAP

trade diam.	100	110	120	130	140	150	160	180	200	225	250	300	350	400	450	500
d2	-	111	122	131	139	151	161	180	200	225	250	300	-	-	-	-
d3	-	245	245	245	295	295	335	380	380	410	430	480	-	-	-	-
L	-	200	225	225	240	240	240	265	265	285	300	330	-	-	-	-

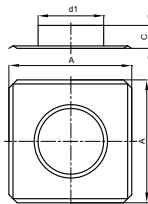

ROOF PASSAGE

trade diam.	110	120	130	140	150	160	180	200	225	250	300	350	400	450	500
	210	220	230	230	250	250	280	300	325	350	400	450	500	550	600
C	50	50	50	50	50	50	50	50	50	50	50	50	50	50	50
A	380	380	380	380	400	400	450	450	500	500	600	600	650	700	750

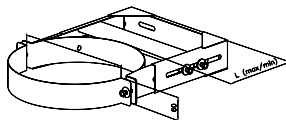

CLAMPING RING OBD 1, 2 OR 3

trade diam. d	200	225	250	300	350	400	450	500
trade diam. D	300	325	350	400	450	500	550	600

RANGE OF ADJUSTMENT:
 - OBD 1: 70-150 mm
 - OBD 2: 150-300 mm
 - OBD 3: 300-500 mm

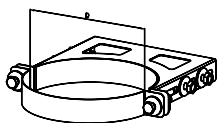

CLIP OBL

trade diam. d	110	120	130	140	150	160	180	200	225	250
trade diam. D	210	220	230	230	250	250	280	300	325	350

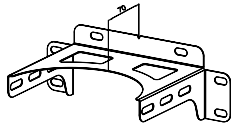

SUPPORT W1 OBL

trade diam. d	110	120	130	140	150	160	180	200	225	250
trade diam. D	210	220	230	230	250	250	280	300	325	350

RANGE OF ADJUSTMENT: CLIP OBL + SUPPORT W1 OBL: 70-150 mm.

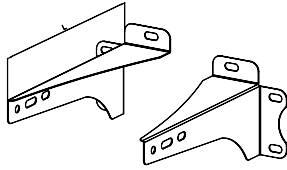

SUPPORT W2, W3, W4 OBL

	Range of adjustment	L
Support W2 OBL	150 - 250	240
Support W3 OBL	250 - 330	340
Support W4 OBL	350 - 430	440

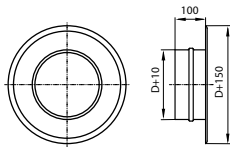

ROSETTE

trade diam.	110	120	130	140	150	160	180	200	225	250	300	350	400	450	500
	210	220	230	230	250	250	280	300	325	350	400	450	500	550	600
D	213	223	233	233	251	251	283	300	328	353	403	451	501	551	601

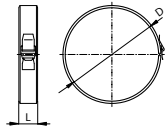

MOUNTING CLAMP

trade diam.	110	120	130	140	150	160	180	200	225	250	300	350	400	450	500
	210	220	230	230	250	250	280	300	325	350	400	450	500	550	600
D	213	223	233	233	251	251	283	300	328	353	403	451	501	551	601
L	35	35	35	35	35	35	35	35	35	35	35	35	95	95	95

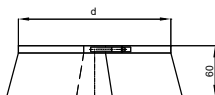

RAIN COWL (OPD)

trade diam.	110	120	130	140	150	160	180	200	225	250	300	350	400	450	500
	210	220	230	230	250	250	280	300	325	350	400	450	500	550	600
D	213	223	233	233	251	251	283	300	328	353	403	451	501	551	601



1. Measure stub pipe

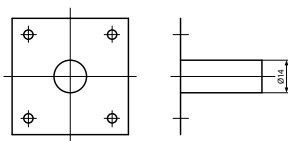

2. Stub pipe plug

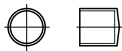

1. Measure stub pipe

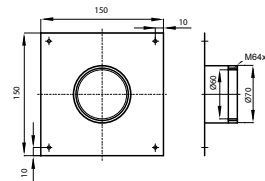

2. Stub pipe plug

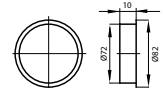

ASSEMBLY MANUAL

VERSION I AND II

1. Forge openings in the wall according to the flue pipe run.
2. Set two rings in the opening for the flue pipe (on both sides of the wall) in such a way so that their common axis is level.
3. Mount a horizontal pipe into the embedded rings. Make sure that the flue operates in a slide manner.
4. Fix an connecting component with the boiler's flue on the pipe from item 3, from the side of the boiler station. When an adjustable component is used, adjust the dimension, lock and seal the pipes facing one another.
5. Mount a tee with a washout hole on the external side of the pipe from item 3 and fix them facing one another with a mounting clamp.
6. Find a vertical axis for the chimney in a defined distance from the external wall.
7. Mount the flue chimney's support console.
8. Mount counterbalance consoles in intended places as the chimney's installation progresses (see figures 1, 2).
9. Mount the chimney's vertical sections one by one. If an installation drawing is provided, the mounting sequence should follow the assigned numbering. Clamp particular elements with the use of mounting clamps. Mount the clamps according to the symbols placed on the inner side of the element. The method of mounting the chimney's particular elements is shown on the drawings: „Mounting stages of chimney elements”.
10. Fasten the mounted flue chimney to the external wall with available clamping rings every approx. 2 m (see figures 1, 2).
11. The last clamping ring needs to be located no more than 0.1 to 0.2 m from the wall top.
12. The maximum height of the chimney between the supports is 15m. If the chimney is higher, use counterbalance console.
13. Mount the last two pipe elements separately and put a mouthpiece over them. The connection may be additionally strengthened by jacket riveting.
14. Mount the chimney termination prepared in this manner on the installed flue chimney and fix with the last clamping ring. Pay attention to the maximum projection of the chimney above the last clamping ring (see figures 1, 2).

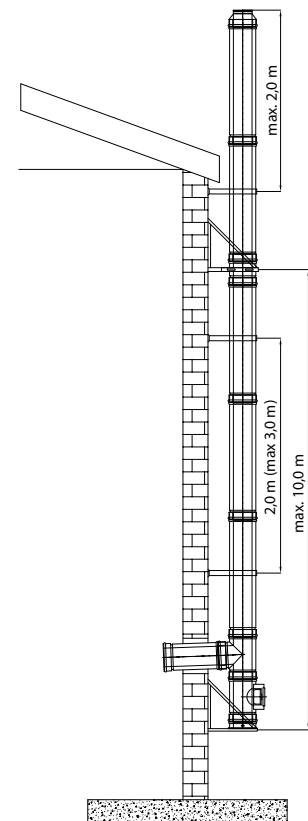
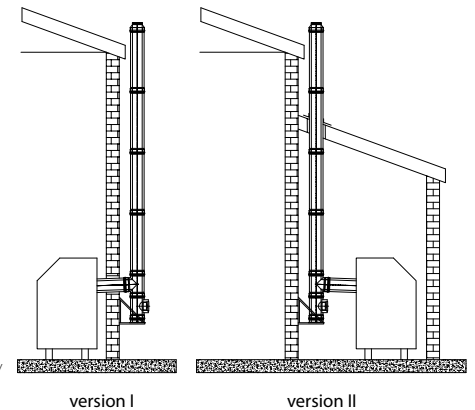

Fig. no. 1

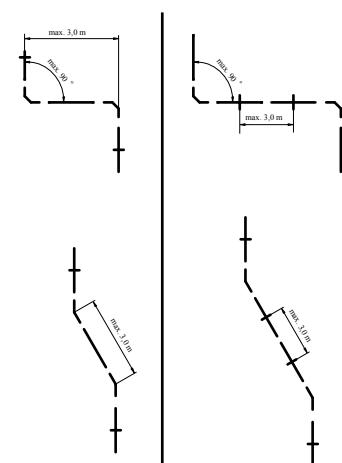
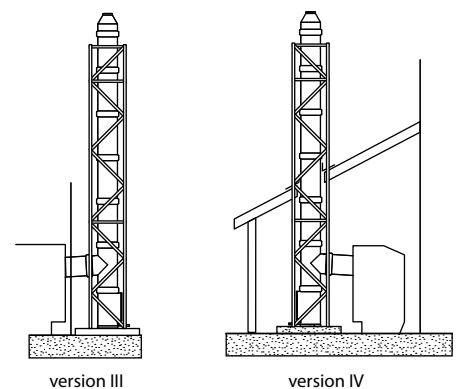

Fig. no. 2

ASSEMBLY MANUAL

VERSION III AND IV



version III

version IV

1. The chimney is mounted by putting chimney fittings one onto the other. It is recommended to mount the chimney horizontally in sections or as a whole (if the height makes this possible).
2. Mount the base of the chimney in a specially prepared support structure.
3. Insert a pre-assembled washout hole with a tee inside the support structure and lean it against the chimney base.
4. Mount the clamping ring located closest to the tee to the support structure.
5. Insert a straight pipe into the support structure and mount it to the tee according to the drawing „Mounting stages of chimney elements”.
6. Fix the pipe (from item 5) to the support structure with the use of a clamping ring (from item 4).
7. Mount sections of the chimney one by one according to the drawing „Mounting stages of chimney elements”.
8. When mounting the chimney, at the same time mount the clamping rings according to the design of the support structure. Pay attention to the spiral location of clamping rings with respect to the support structure.
9. Mount the mouthpiece to the last pipe element (according to the drawing „Mounting stages of chimney elements”).
10. Set the support structure, together with the chimney, vertical and fix it to the foundation.
11. Mount the connection (the flue) according to the available documentation.
12. If the chimney is mounted vertically, follow the instructions from items 3 to 9.

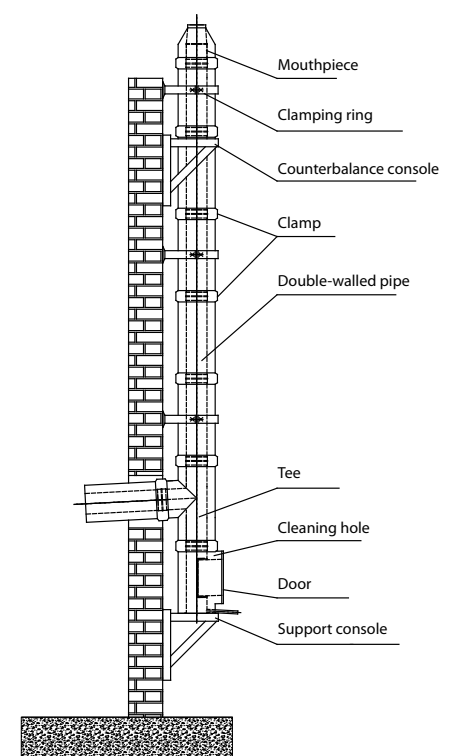

1. Preparation stage
(advanced internal pipe)

2. Mounting stage
(elements partially drawn over one another)

3. Assembled elements
(stiffened with the use of a mounting clamp)

4. Cutting the cylindrical pipe

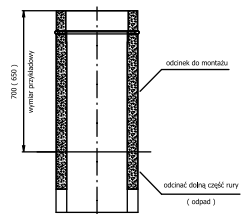
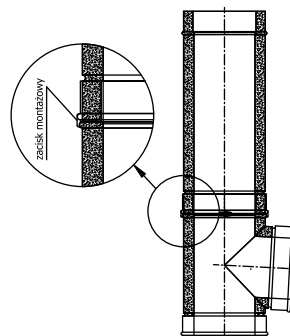
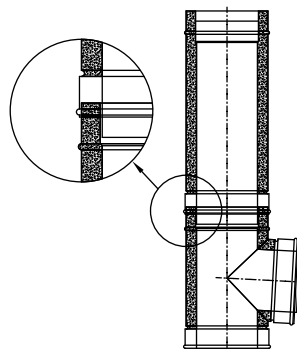
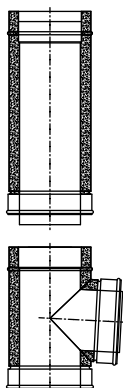

Mounting stages of chimney elements