

ASSEMBLY MANUAL

I. Identification of heating unit

Using the instruction manual for a heating unit, identify whether the installed unit is a condensation or a non-condensation boiler.

II. Discharging condensate

In the case of a condensation boiler, the condensate coming from exhaust flue gases is discharged through the boiler. The system of discharging exhaust flue gases does not require the application of condensers and may be built on the basis of knees. In the case of a non-condensation boiler, the system of discharging exhaust flue gases needs to be equipped with elements discharging the condensate. The condensate must not return to the boiler. Chimneys should be built on the basis of connection tees equipped with condensers. If it is impossible to apply the solution referred to above, the condensate should be discharged from horizontal sections (the flue) connecting the boiler with the chimney with the use of special system fittings. All condensers need to be equipped with traps, preventing an uncontrolled outflow of exhaust flue gases from the chimney system.

III. Chimney configuration

Configure the chimney using instructions from the boiler's manufacturer. They are usually contained in the instruction manual or the assembly manual for the heating unit. Pay particular attention to the selection of the flue system in terms of its flow resistances. The boiler manufacturer usually defines the maximum acceptable chimney height, the method for calculating resistances from the flue system as well as the maximum value of resistance which should not be exceeded.

IV. Detailed guidelines for assembly

1. All pipe elements may be freely shortened from the side of the pipe (not the muff) with the use of tools for acid-proof steel.
2. In order to set the assembly and avoid damage to seals when inserting the pipe into the muff, moisten the point of contact between the seal and the pipe.
3. Blunt sharp edges, in particular bevel towards the inside of the flue pipe, in order to avoid damage to the seal during assembly.
4. NOTE: Mount the SPS system, diameter above 100 mm, which requires a preliminary matching of the components (e.g. complex flues) in two stages. Stage one: pre-assembly without seals, enabling a problem-free disassembly, e.g. in order to shorten pipes. Stage two: final assembly of elements with seals. The disassembly of elements equipped with seals may be difficult.
5. Depending on the variant, forge openings in walls, to the chimney or in ceilings.
6. When necessary, mount an adapter on the boiler (variant A to E) or adapters - in the case of a separate air-combustion system (variant F and G).
7. In variants C, D, E and G with the flue duct in the chimney - mount the bottom element to the chimney (knee or tee with condenser) remembering to place them with respect to the chimney with the use of a special clamping ring or a stable base.
8. Connect the vertical sections of pipes remembering to apply special roof passages and chimney ends in their upper part (variants B, C, D, E, G). When necessary, center the system with respect to the shaft with the use of centering elements.
9. In variants C, D, E and G connect the horizontal sections of boiler connections with the vertical sections, sealing them with rings with respect to the openings in walls and chimneys. Use a special sealing ring especially in variant E.
10. In variants A, F and G connect the horizontal sections of connections with side outlets, sealing them with rings with respect to walls as in item 5.
11. Maintain an appropriate inclination (fall) of the run of flue duct horizontal sections during the assembly:
 - for a condensation boiler with a closed combustion chamber inclination towards the boiler
 - for a non-condensation boiler with a closed combustion chamber inclination opposite to the boilerNOTE: permanent impact of accumulated of condensate on improperly inclined sections of flue ducts may damage the seals or the surface passivation layer of the duct.

V. Comments

1. To ensure safety of assembly and use, the assembly should be conducted by companies with the manufacturer's authorizations.

Basic variants of flue connections to boilers with a closed combustion chamber
(the presented variants cannot be treated as designs of technical solutions)

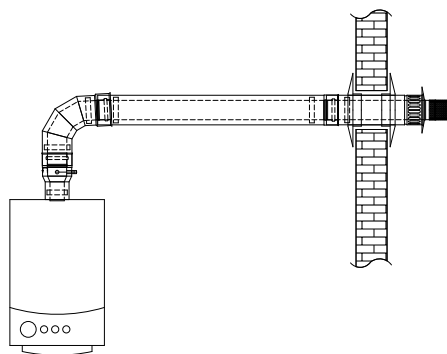

variant A

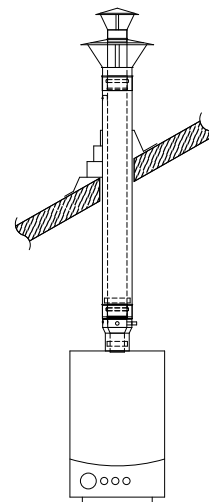

variant B

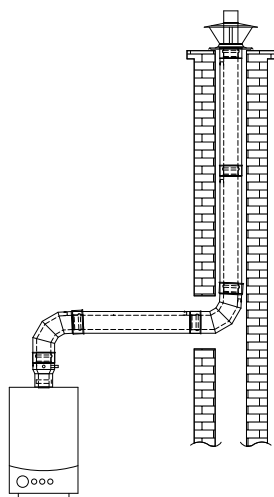

variant C

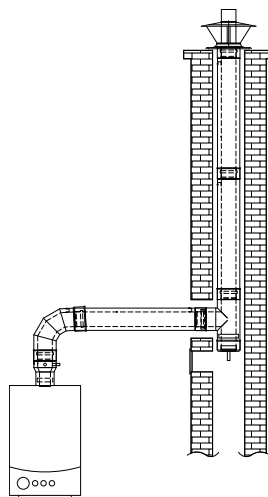

variant D

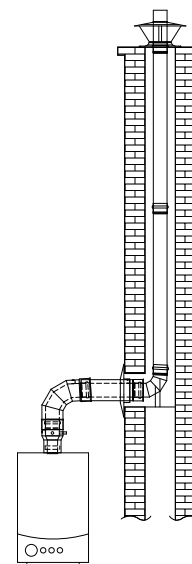

variant E

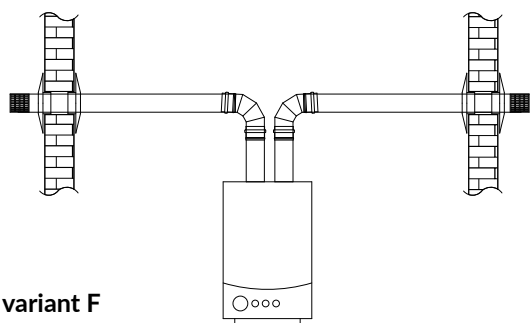

variant F

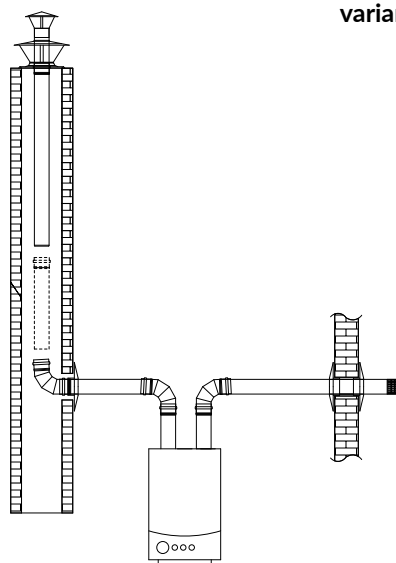

variant G

Variants of air / flue connections for multi-boiler systems.
 (Presented variants can not be considered as technical solutions projects)

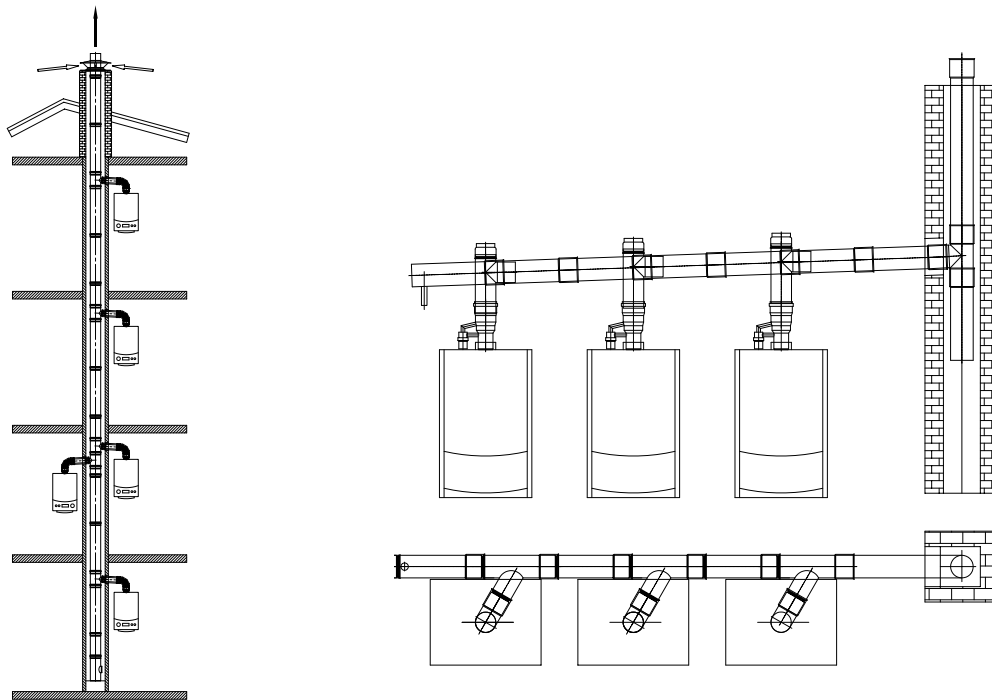

Basic methods of installing ZKS heating units.

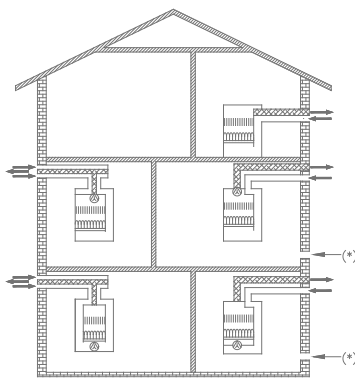

Type of unit "C1"

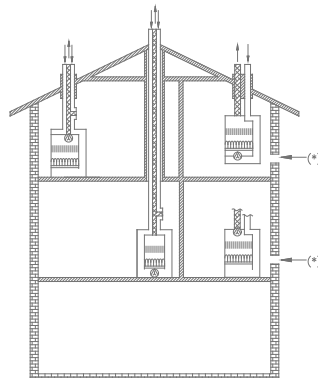

Type of unit "C3"

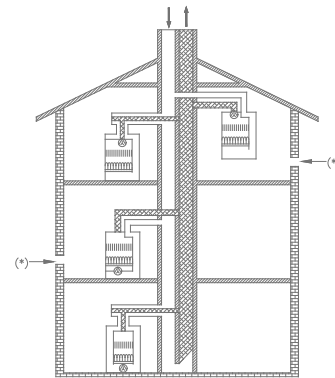

Type of unit "C4"

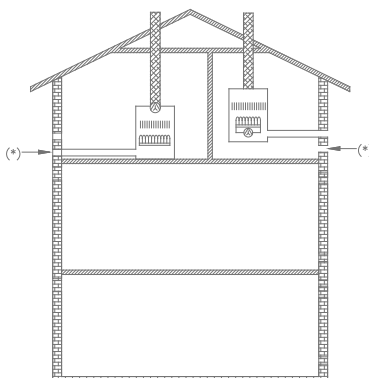

Type of unit "C5"

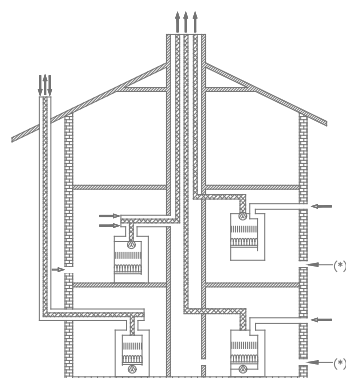

Type of unit "C6"

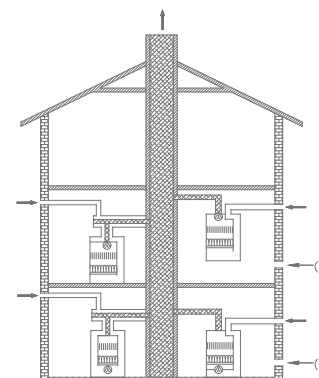

Type of unit "C8"

Variants of air-to-air connections for heaters and radiators
(Presented variants can not be considered as technical solutions projects)

