

POSITIVE PRESSURE CHIMNEYS

INSULATED CHIMNEYS TYPE SPS IZOL

Example of marking elements manufactured according to the standard EN 1856-2

SPS EN 1856-2 T120 P1 W V_m L30050 O500

Standard number	↓								
Maximum working temperature		↓							
Pressure class (N: negative pressure, P: positive pressure)			↓						
Resistance to condensate (W: wet; D: dry)				↓					
Resistance to corrosion according to type and thickness of material					↓				
Material specification (20-1.4301, 30-1.4307)						↓			
Thickness of material (0.XX mm)							↓		
Resistance to soot fire (G: yes; O: no, distance from flammable materials (500 mm))								↓	



POSITIVE PRESSURE CHIMNEYS

INSULATED CHIMNEYS TYPE SPS IZOL

Insulated SPS IZOL chimneys are independent chimney systems. Made of acid-resistant steel, they discharge smoke from condensing boilers operating in positive pressure conditions. They include a 25-30 mm thick insulation which allows installing them outside the building.

Insulated SPS IZOL systems are made based on SPS positive pressure chimney liners, with additional insulation made of mineral wool with a density of 100 kg/m³ and an outer jacket made of acid-resistant steel. The wool prevents excessive cooling of the chimney walls. In order to ensure stiffness at larger diameters, additional grooves on elements are used. The tightness of the smoke elements is ensured thanks to specially shaped gaskets. The seal is made of a material that is resistant to combustion products. Thanks to the applied solutions, the elements have the P1 air-tightness class, i.e. they can operate at a positive pressure of up to 200 Pa.

The system is designed to be installed outside the building or inside when it passes through an unheated room. Unlike discharging smoke outside the wall, the system of discharging smoke above the roof prevents damaging the facade or smoke penetrating into interiors. The air is supplied directly from the space behind the wall.

Positive pressure chimneys comply with the following European standards: EN 1856-2 and EN 14989-2. The production of all positive pressure elements is covered by a system of factory production control, certificate No 1020-CPD-070038635 and 1020-CPD-070038639 (TZUS Praga). KOMIN-FLEX has implemented and maintains a quality management system compliant with the requirements of the standard EN ISO 9001:2015 certified by TZUS Praga.

Chimneys by KOMIN-FLEX have received a positive opinion and are recommended by the professional association of Polish chimney sweeps.

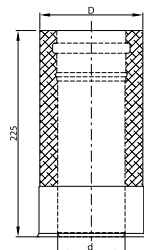

PIPE 0,25 m INSULATED SPS

trade diam. d	80	100
D	120	150

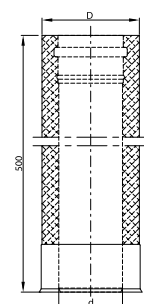

PIPE 0,5 m INSULATED SPS

trade diam. d	80	100
D	120	150

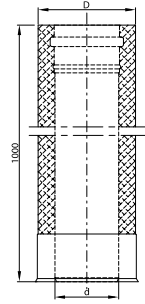

PIPE 1m INSULATED SPS

trade diam. d	80	100
D	120	150

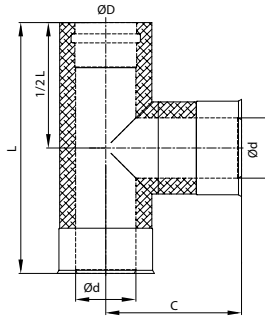

TEE 87° INSULATED SPS

trade diam. d	80/125	100/150
d	80	100
d1	82	102
D	122	150
D1	124	152
L	333	333
C	180	150

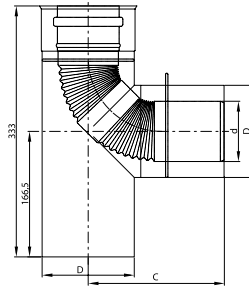

TEE ELBOW 87° INSULATED SPS

trade diam. d	80	100
D	120	150
C	180	200

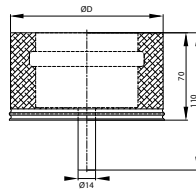

BOTTOM INSULATED SPS

trade diam. d	80	100
D	120	150

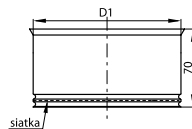

INTAKE BOTTOM

trade diam. d	80	100
D1	124	152

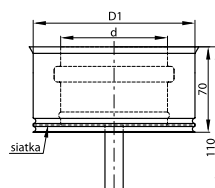

INTAKE BOTTOM WITH CONDENSER

trade diam. d	80	100
d1	82	102
D1	124	152

New quality

CLIP OBL SLIM

trade diam. d	80	100
trade diam. D	120	150

SUPPORT W1 OBL SLIM

trade diam. d	80	100
trade diam. D	120	150

COUNTERBALANCE CONSOLE PLATE INSULATED SPS

trade diam. d	80	150
D	120	150

COUNTERBALANCE CONSOLE PLATE INSULATED SPS/WSPS

trade diam. d	80	100
d1	82	102
D	120	150

CONSOLE SUPPORT INSULATED SPS SET

trade diam. d	80	100
---------------	----	-----

ELBOW 45° INSULATED SPS

trade diam. d	80	100
D	120	150

UPPER INSULATION ENDING

trade diam. d	80	100
D1	124	152

INSULATION ENDING

trade diam. d	80	100
D	120	150

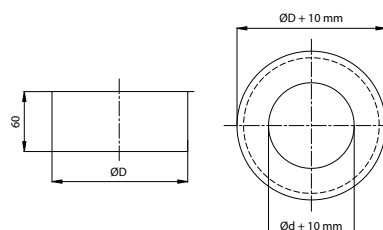
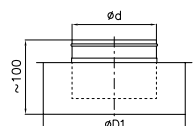
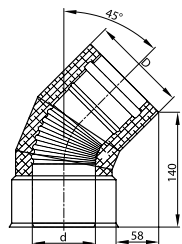
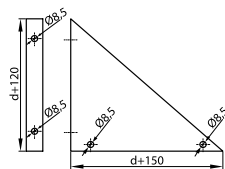
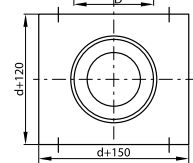
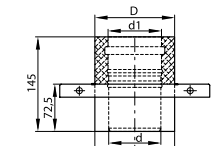
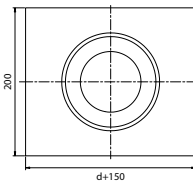
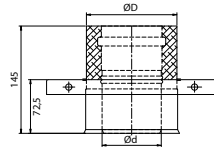
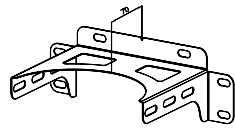
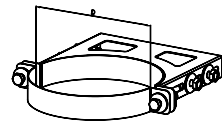

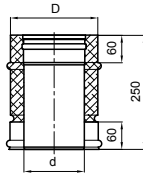

PIPE 0,25 m INSULATED SPS

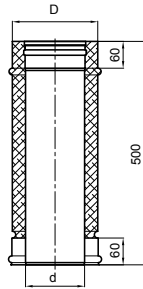
trade diam. d	130	150	160	180	200	225	250	300
trade diam. D	190	210	220	240	260	285	310	360

PIPE 0,5 m INSULATED SPS

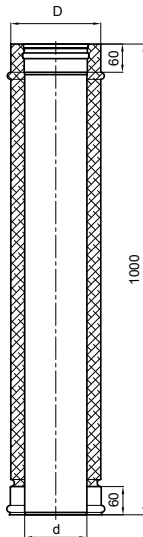
trade diam. d	130	150	160	180	200	225	250	300
trade diam. D	190	210	220	240	260	285	310	360

PIPE 1 m INSULATED SPS

trade diam. d	130	150	160	180	200	225	250	300
trade diam. D	190	210	220	240	260	285	310	360

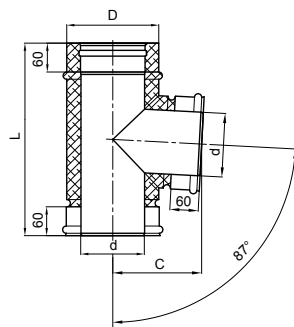
TEE 87° INSULATED SPS

trade diam. d	130	150	160	180	200	225	250	300
trade diam. D	190	210	220	240	260	285	310	360
L		400		450		500		550
C	185	195	200	210	220	233	245	270

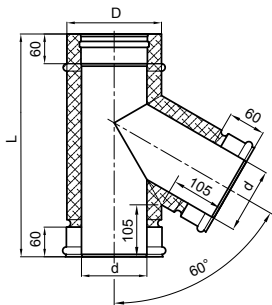

TEE 60° INSULATED SPS

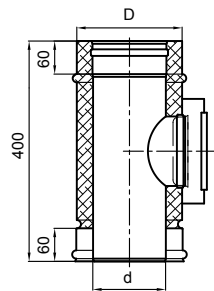
trade diam. d	130	150	160	180	200	225	250	300
trade diam. D	190	210	220	240	260	285	310	360
L		450		500		550		600

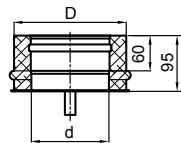

CLEANING HOLE INSULATED SPS

trade diam. d	130	150	160	180	200	225	250	300
trade diam. D	190	210	220	240	260	285	310	360



BOTTOM INSULATED SPS

trade diam. d	130	150	160	180	200	225	250	300
trade diam. D	190	210	220	240	260	285	310	360

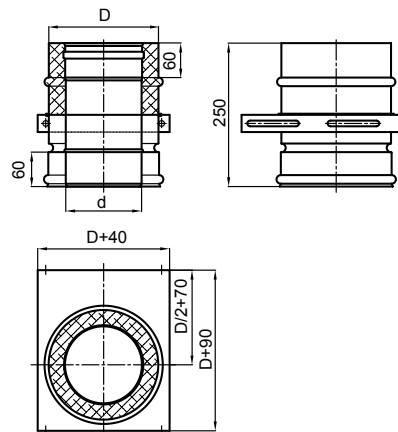

COUNTERBALANCE CONSOLE PLATE INSULATED SPS

trade diam. d	130	150	160	180	200	225	250	300
trade diam. D	190	210	220	240	260	285	310	360

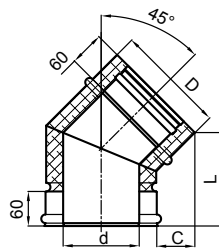

ELBOW 45° INSULATED SPS

trade diam. d	130	150	160	180	200	225	250	300
trade diam. D	190	210	220	240	260	285	310	360
L	162							
C	45							

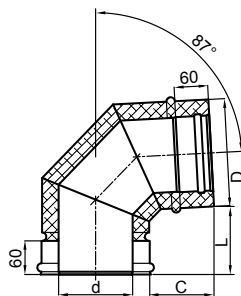

ELBOW 87° INSULATED SPS

trade diam. d	130	150	160	180	200	225	250	300
trade diam. D	190	210	220	240	260	285	310	360
L	120							
C	115							

ASSEMBLY MANUAL

I. Identification of heating unit

Using the instruction manual for a heating unit, identify whether the installed unit is a condensation or a non-condensation boiler.

II. Discharging condensate

In the case of a condensation boiler, the condensate coming from exhaust flue gases is discharged through the boiler. The system of discharging exhaust flue gases does not require the application of condensers and may be built on the basis of knees. In the case of a non-condensation boiler, the system of discharging exhaust flue gases needs to be equipped with elements discharging the condensate. The condensate must not return to the boiler. Chimneys should be built on the basis of connection tees equipped with condensers. If it is impossible to apply the solution referred to above, the condensate should be discharged from horizontal sections (the flue) connecting the boiler with the chimney with the use of special system fittings. All condensers need to be equipped with traps, preventing an uncontrolled outflow of exhaust flue gases from the chimney system.

III. Chimney configuration

Configure the chimney using instructions from the boiler's manufacturer. They are usually contained in the instruction manual or the assembly manual for the heating unit. Pay particular attention to the selection of the flue system in terms of its flow resistances. The boiler manufacturer usually defines the maximum acceptable chimney height, the method for calculating resistances from the flue system as well as the maximum value of resistance which should not be exceeded.

IV. Detailed guidelines for assembly

1. All pipe elements may be freely shortened from the side of the pipe (not the muff) with the use of tools for acid-proof steel.
2. In order to set the assembly and avoid damage to seals when inserting the pipe into the muff, moisten the point of contact between the seal and the pipe.
3. Blunt sharp edges, in particular bevel towards the inside of the flue pipe, in order to avoid damage to the seal during assembly.
4. NOTE: Mount the SPS system, diameter above 100 mm, which requires a preliminary matching of the components (e.g. complex flues) in two stages. Stage one: pre-assembly without seals, enabling a problem-free disassembly, e.g. in order to shorten pipes. Stage two: final assembly of elements with seals. The disassembly of elements equipped with seals may be difficult.
5. Depending on the variant, forge openings in walls, to the chimney or in ceilings.
6. When necessary, mount an adapter on the boiler (variant A to E) or adapters - in the case of a separate air-combustion system (variant F and G).
7. In variants C, D, E and G with the flue duct in the chimney - mount the bottom element to the chimney (knee or tee with condenser) remembering to place them with respect to the chimney with the use of a special clamping ring or a stable base.
8. Connect the vertical sections of pipes remembering to apply special roof passages and chimney ends in their upper part (variants B, C, D, E, G). When necessary, center the system with respect to the shaft with the use of centering elements.
9. In variants C, D, E and G connect the horizontal sections of boiler connections with the vertical sections, sealing them with rings with respect to the openings in walls and chimneys. Use a special sealing ring especially in variant E.
10. In variants A, F and G connect the horizontal sections of connections with side outlets, sealing them with rings with respect to walls as in item 5.
11. Maintain an appropriate inclination (fall) of the run of flue duct horizontal sections during the assembly:
 - for a condensation boiler with a closed combustion chamber inclination towards the boiler
 - for a non-condensation boiler with a closed combustion chamber inclination opposite to the boilerNOTE: permanent impact of accumulated condensate on improperly inclined sections of flue ducts may damage the seals or the surface passivation layer of the duct.

V. Comments

1. To ensure safety of assembly and use, the assembly should be conducted by companies with the manufacturer's authorizations.

Basic variants of flue connections to boilers with a closed combustion chamber
(the presented variants cannot be treated as designs of technical solutions)

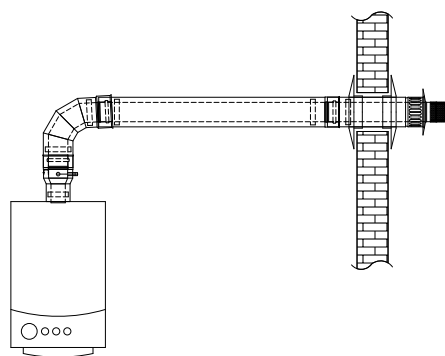

variant A

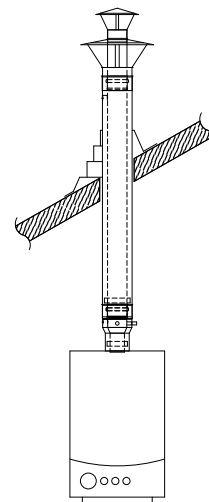

variant B

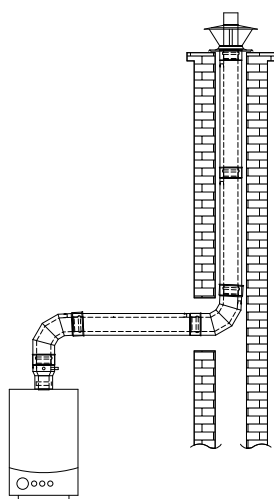

variant C

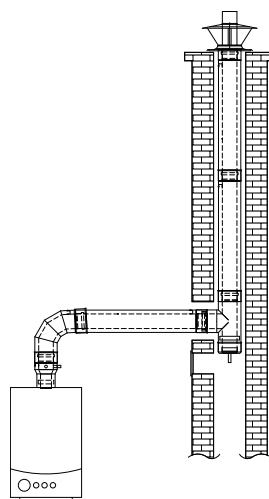

variant D

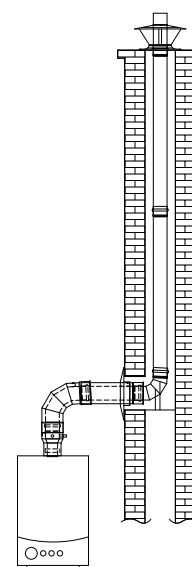

variant E

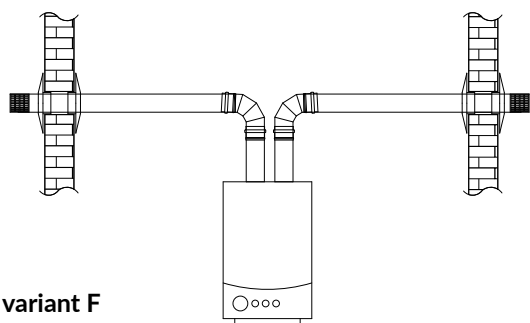

variant F

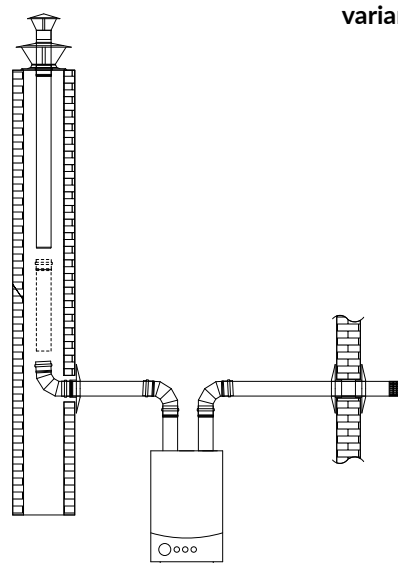

variant G

Variants of air / flue connections for multi-boiler systems.
 (Presented variants can not be considered as technical solutions projects)

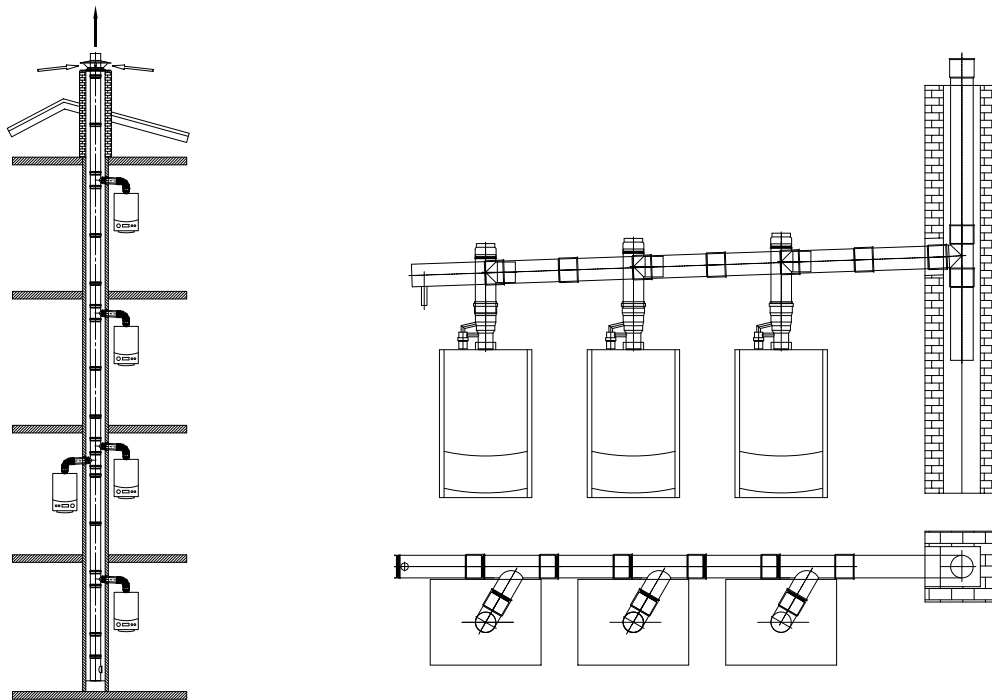

Basic methods of installing ZKS heating units.

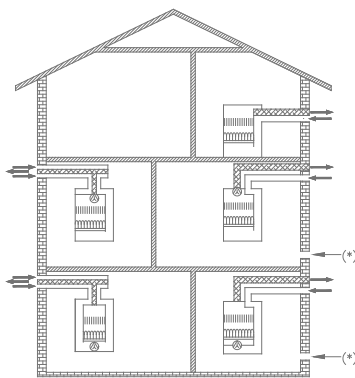

Type of unit "C1"

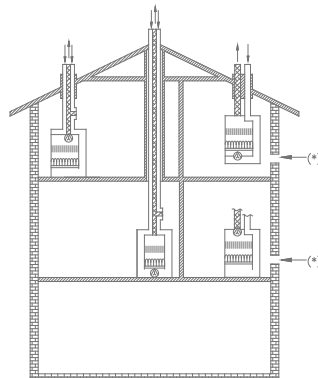

Type of unit "C3"

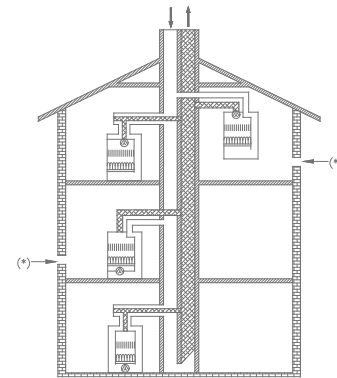

Type of unit "C4"

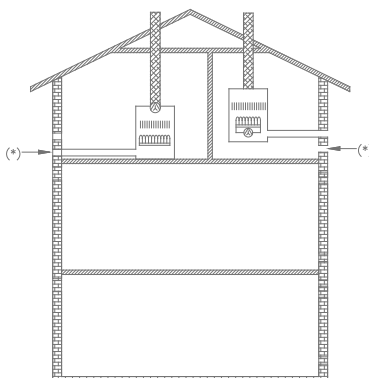

Type of unit "C5"

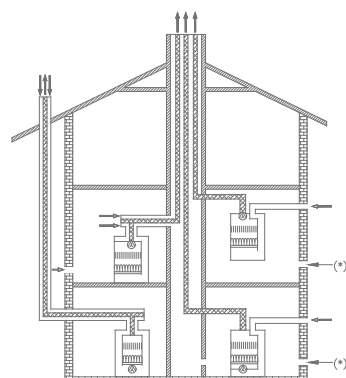

Type of unit "C6"

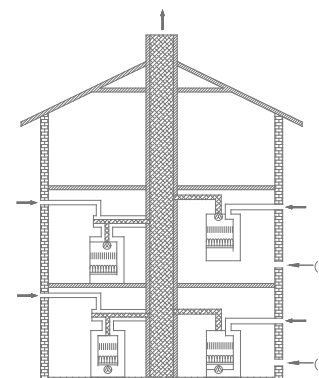

Type of unit "C8"

Variants of air-to-air connections for heaters and radiators
(Presented variants can not be considered as technical solutions projects)

